

Antipassive structure in Tenetehára (Tupí-Guarani family)

Estrutura antipassiva em Tenetehára (família Tupí-Guaraní)

Fábio Bonfim Duarte¹

Quesler Fagundes Camargos²

Ricardo Campos de Castro³

Resumo: O presente trabalho pretende descrever e examinar as construções antipassivas na língua Tenetehára (família linguística Tupí-Guaraní). Mostraremos que as construções transitivas, ao receberem o morfema {puru-}, passam a exibir as seguintes propriedades gramaticais típicas de sentenças antipassivas: (i) elas adquirem estrutura sintática intransitiva e (ii) o Caso abstrato do argumento interno não é valorado pelo v , mas pela posposição *-ehe*. Usando uma abordagem minimalista, mostraremos que a principal diferença entre uma oração antipassiva e uma transitiva é que embora o vP antipassivo selecione um argumento externo, seu núcleo não é capaz de valorar o Caso abstrato do argumento interno. Por essa razão, o objeto é dependente da posposição *-ehe* para o Caso oblíquo. Além disso, diferentemente do que acontece na derivação de construções transitivas, o traço- ϕ do vP antipassivo é lexicalmente valorado, o que não permite a concordância (sistema nominativo), em termos de traços- ϕ , com seu argumento externo. O resultado é que este argumento externo se move para uma posição de Spec- vP mais alta na configuração arbórea, cujo núcleo é instanciado pelo verbo {-wer} “querer”, com o qual este DP estabelece concordância em termos de traços- ϕ , desencadeando o segundo paradigma de concordância (sistema absoluto).

Palavras-chave: Tenetehára (Tupí-Guaraní); Construção Antipassiva; Programa Minimalista; Valoração de Traços.

Abstract: This article aims to describe and examine the antipassive construction in the Tenetehára language (Tupí-Guarani family). For this, it will be shown that the transitive verbs, on receiving the morpheme {puru-}, then exhibit the following properties of antipassive constructions: (i) they come to have an intransitive syntactic structure and (ii) the abstract Case of the internal argument is not valued by v , but by the postposition *-ehe*. Generally, such configurations behave essentially like intransitive sentences. Using a minimalist approach, we show that the main difference between an antipassive clause and a transitive one is that although the antipassive vP selects an external argument, its head is not able to value the abstract Case of the internal argument. For this reason, the object is dependent on the postposition *-ehe* for the oblique Case. Furthermore, unlike what happens in the derivation of transitive constructions, the ϕ -feature of the antipassive vP is lexically

¹ Federal University of Minas Gerais. E-mail: fbonfim@terra.com.br

² Federal University of Rondônia. E-mail: queslerc@yahoo.com.br

³ Federal University of Minas Gerais. E-mail: ricardorrico@uol.com.br

valued, which does not allow the agreement (nominative system) in terms of ϕ -feature, with its external argument. The result is that this external argument moves to the highest vP Spec position in the tree structure, whose head is instantiated by the verb $\{-wer\}$ “want”, with which it establishes a relationship agreement in terms of ϕ -feature, triggering the second agreement paradigm (absolutive system).

Keywords: Tenetehára (Tupi-Guarani); Antipassive Construction; Minimalist Program; Features Valuation.

1. Introduction

This article⁴ aims to describe and examine the antipassive construction in the Tenetehára language. Dialect variants of the Tenetehára language are spoken in northeastern Brazil by two indigenous peoples: the Tembé and the Guajajára. According to Rodrigues (1985), this language belongs to Branch IV of the Tupi-Guarani linguistic family, of the Tupi Trunk. We will show that the transitive verbs, on receiving the morpheme $\{puru-\}$, show grammatical properties that are typical of antipassive constructions. These characteristics appear in other languages that also exhibit this phenomenon, as shown by the examples⁵ below⁶:

⁴ The research represented constitutes a major project, entitled Ergativity in Brazilian Languages and its consequences to Case Theory, and has been funded by CNPq, process number # 456052/2014-3 and by FAPEMIG, process number # 19901. The reader may find further information on this project in the following webpages www.letras.ufmg.br/fbonfim and www.letras.ufmg.br/portal_laliafro.

⁵ Abbreviations used in this paper: _{NOM}: nominative system (first agreement paradigm in Tenetehára); _{ABS}: absolutive system (the second agreement paradigm in Tenetehára); ABS: absolutive Case; ACC: accusative Case; APASS: antipassive morpheme; APPL: applicative morpheme; C: the prefix that marks the adjacency of the complement; CAUS: causative morpheme; CORR: correferencial prefix $\{w- \sim o- \sim u-\}$; WANT: desiderative (“want” and “desire”); ERG: ergative Case; INDIC: indicative; INS: instrumental Case; INTS: intensifier morpheme; INTRANS: intransitive; NOM: nominative Case; PERF: perfective aspect; PSP: postposition; PREP: preposition; REFL: reflexive prefix; SG: singular; TRANS: transitive.

⁶ In descriptive terms, in the Tenetehára language, personal pronouns (*ihe* “I”, *zane* “we inclusive”, *ure* “we exclusive”, *ne* “you (sg)”, *pe* “you (pl)”, *a’e* “s/he”) may be placed at the end of each sentence in order to restate the subject of unergative, unaccusative and transitive verbs of the main clauses. According to Camargos (2015), one theoretical hypothesis would be to assume that this final pronoun is the reflex of a universally present set of phi-features in C domain, as the in following examples:

- | | | | | | | |
|------|--|------------------|---------------|--------------------------|-------------|------------|
| (i) | <i>a-zàn</i> | <i>zàwàruhu</i> | <i>ø-wi</i> | <i>i-hem</i> | <i>mehe</i> | <i>ihe</i> |
| | 1SG _{NOM} -run | jaguar | c-from | 3 _{ABS} -arrive | when | I |
| | “I ran from the jaguar _k when it _k came” | | | | | |
| | | | | | | |
| (ii) | <i>u-’ar</i> | <i>kwarer he</i> | <i>ø-ku’a</i> | <i>ø-wi</i> | | <i>a’e</i> |
| | 3 _{NOM} -fall | boy my | c-waist | c-from | | he |
| | “The boy fell from my waist” | | | | | |

- 1) *u-pyhyk* *kwarer* *pira* *a'e*
 3_{NOM} -catch boy fish he
 “The boy caught the fish”
- (2) *i-puru-pyhyk-wer* *kwarer* *pira* *r-ehe* *a'e*
 3_{ABS} -APASS-catch-WANT boy fish C-PSP he
 “The boy wants to catch the fish”

These constructions, although they semantically select two core arguments, behave in formal terms as intransitive sentences, since (i) they receive intransitive verb morphology and (ii) the abstract Case of the internal argument is not valued by the verb, but rather by the postposition *-ehe*. Following recent developments in the theory of Case, the main objective of this article is to seek an explanation of how antipassive construction is syntactically derived in Tenetehára. To this end, we argue in favor of the hypothesis that although the antipassive *vP* selects an external argument, its head is not able to value the abstract Case of its internal argument. The paper is organized in five sections, namely: in section 2, we display, according to linguistic typology, the main features of antipassive constructions in natural languages; in section 3, we show the antipassive constructions in Tenetehára looking for evidence that indeed they may receive such a classification; in section 4, we present our theoretical proposal within a minimalist approach; finally, section 5 concludes this paper with some final considerations.

2. Antipassives constructions in natural languages

Following proposals in linguistic typology, as advocated, for example, in Givón (1993), the antipassive voice is a type of construction that is generated from the alteration of nuclear grammatical functions of the basic transitive clause. In this operation, the direct object becomes oblique since it comes with a postposition. However, the subject can trigger the same agreement that objects and intransitive subjects establish with the verb. In such contexts, it is common to show the same Case as these arguments. This fact explains why, in an antipassive construction, an argument such as the patient, which is usually realized as a direct object in an active transitive construction, can be either deleted (left implicit) or realized as an oblique complement.

The term “antipassive” was first proposed by Silverstein (1976) in order to indicate that this construction is the passive’s mirror image, as follows: in

-
- (iii) *u-zuka* *kwarer* *zapukaz* (*a'e*) *wà*
 3_{NOM} -kill boy chicken he PL
 “The boys killed the chicken”

the passive voice, the constituent deleted or demoted is the external argument, while in antipassive voice, the participant deleted or demoted is the internal argument, which tends to be the argument that receives the thematic role of patient/affected. According to Givón (1993), the passive and antipassive voices constitute two extremes in pragmatic detransitivization. Therefore, the author postulates that the intransitivized antipassive contrasts with the transitive, as it allows the direct object of transitive to be demoted to oblique. In addition, the main difference between passive and antipassive is that in the passive, the direct object is promoted to subject, while in antipassive, the direct object is demoted to oblique. In short, the basic difference between the three types of voices can be schematically represented in the following table (cf. Givón 1993:78):

Table 1. Relative topicality of agent and the patient

Voice	Topicality gradient	Pragmatically Supressed
Active	agent > patient	/
Passive	patient >> agent	agent
Antipassive	agent >> patient	patient

The pertinent literature lists a wide range of grammatical properties with respect to antipassive voice. For this reason, we reconsider here some of these characteristics in order to demonstrate to the reader that the syntax of the language Tenetehára indeed displays such constructions. We start, then, with the Tagalog data. According to Aldridge (2012), in this language, the intransitive construction must trigger the intransitive morpheme {-um-}, while the transitive construction triggers the transitive morpheme {-in-}. Compare to the following examples:

- (3) a. *B<in>ili ng babae ang isda*
 <TR PERF>buy ERG woman ABS fish
 “The woman bought the fish” (Aldridge 2012:1)
- b. *D<um>ating ang babae*
 <INTR PERF>arrive ABS woman
 “The woman arrived” (Aldridge 2012:1)

According to the author, the Tagalog language displays an ergative pattern of agreement Case. Note that in (3a), the transitive verb *ili* “buy” selects two DPs, namely, the external argument *babae* “woman” and the internal argument *isda* “fish”. While in (3b), the intransitive verb *ating* “arrive” selects a nuclear argument, the DP *babae* “woman.” Note, additionally, that, when comparing

the two clauses above, both the object of the transitive sentence as well as the subject of the intransitive appear with exactly the same absolutive Case morpheme *ang*. Thus, the author shows that in fact the Tagalog language has an ergative-absolutive alignment system. Interestingly, note that, in (4) below, the external argument *babae* “woman” of the same transitive predicate *ili* “buy” from (3a), can still display the absolutive Case marker *ang* instead of the ergative Case marker. In addition, the internal argument in (4), different from (3a), is marked with oblique Case. Such changes in the argument structure and in the Case system of the language lead us to conclude that the sentence below represents a typical Case of antipassive construction. Strong evidence for this analysis has to do with the fact that the antipassivized transitive verb has to occur with the intransitive morpheme {-um-}, as shown by the following data:

- (4) *B<um>ili ang babae ng isda*
 <INTR PERF>buy ABS woman OBL fish
 “The woman bought a fish” (Aldridge 2012:1)

Unlike the antipassive above, there is another that, as well as indicating the change of grammatical function through the Case system, may also indicate this change through the agreement system. This is the situation in Greenlandic below:

- (5) a. *Jaaku-p illu sana-va-a*
 Jacob-ERG house.ABS be.building-TR.INDIC-3SG.ERG/3SG.ABS
 “Jacob is/was building house” (Bittner 1987:5)
- b. *.Jaaku illu-mik sana-ø-vu-q*
 Jacob.ABS house-INS be.building-APASS-INTR.INDIC-3SG.ABS
 “Jacob is/was building house” (Bittner 1987:5)

Note that in the transitive clause in (5a), the *sanavaa* verb “to be building” agrees with both arguments: the DP ergative *Jaakup* “Jacob” and the DP absolutive *illu* “home”. Whereas in the antipassive construction (5b), the correlation is established only with the absolutive external argument *Jaaku* “Jacob”. This change in the agreement system is directly related to the fact that the predicate *sanavaa* “to be building” gets the antipassive morpheme {-ø-}, whose function is to intransitivize the transitive verb. In addition to that, the DP object is no longer marked with the absolutive Case but receives the instrumental Case, while the subject stops receiving the ergative Case and is marked with the absolutive Case. In order to highlight the antipassive voice in the context of object demotion with aspectual change, we include the following Yucatec data, where one can observe a construction in the active voice and one in the antipassive, respectively. Note that the event in the transitive version is

telic, while in the intransitive/antipassive version it is atelic. This difference is particularly instantiated because the perfective aspect morpheme {-ik} only appears on the active transitive sentence (6a).

- (6) a. *mà'alog'* *'a-tan-ik* *màayah*
 well 2SG-speak-PERF Maya
 “You speak Maya well” (Blight 2004:113)
- b. *mà'alog'* *'a-t'àan* *'itS* *màayah*
 well 2SG-speak.APASS PREP Maya
 “You speak Maya well” (Blight 2004:114)

In short, the presence versus the aspect morpheme's absence indicates that the grammatical aspect, often, is a determining factor in order to produce the active/antipassive alternation, as predicted by Polinsk (2005). In other words, what the data above show is that the antipassive construction generally covers atelic events.

3. The Antipassive in Tenetehára

Before we discuss the constructions in Tenetehára that involves antipassive structure, we present in the next subsection the verb agreement's systems and the Case system's splitting in that language.

3.1. Agreement systems and splitting of the Case system

Just as in the other members of the Tupi-Guarani language family, the noun phrases in Tenetehára do not receive Case endings to distinguish the DPs in the subject and object's syntactic functions. These syntactic functions are encoded by the first agreement paradigm (for the nominative system) and by the second agreement paradigm (for the absolutive system) in the verb. The first paradigm is comprised of the agreement prefixes, while the second paradigm is comprised of the pronoun clitics, as shown in the tables below (cf. Duarte 2007:44 and Camargos 2010:27).

Table 2. Independent pronouns, agreement prefixes and clitic pronouns

Persons	Independent Pronouns	Agreement Prefixes	Clitic Pronouns
I	ihe	a-	he
weinclusive	zane	xi- ~ za-	zane
weexclusive	ure	uru- ~ oro-	ure
you(sg)	ne	re-	ne
you(pl)	pe	pe-	pe
he	-	u- ~ o- ~ w-	-

Table 3. Relational prefixes

Gramatical persons	Root beginning with consonant	Root beginning with vowel	Distinctive feature
1st/2nd	∅-	r-	[+PERSON]
3rd	i-	h-	[-PERSON]

Based on the typology proposed by Dixon (1979, 1994), Duarte (2007) shows that, in the Tenetehára language, Case split is conditioned by the following factors: (i) the verb’s semantic nature; (ii) the DP’s semantic nature; (iii) and, finally, the grammatical clause’s status (if primary or subordinate). Because of space limitations, we present below only the split conditioned by the semantic nature of the DP⁷.

Subject of transitive (A) = Subject of inergative (Sa)⁸

- (7) a. *a-exak* *zàwàruhu* *ihe*
1SG_{NOM}-see jaguar I
 “I saw the jaguar”

⁷ According to Duarte (2005, 2007, 2012), the person’s hierarchy, following the intuition of Rodrigues (1990), can be explained as follows: the first person is higher than the second person, the second person is more high than focal than the focal third person, finally, the focal third person is higher than the third person no focal. We can formalize this hierarchy as follows: $1 > 2 > 3_{+FOC} > 3_{-FOC}$.

⁸ Following the Dixon’s terminology (1979, 1994), the terms (A), (O), (Sa) and (So) refer, respectively, the subject of transitive, transitive object, subject of inergative and subject of unaccusatives.

- b. *a-zàn* *ka'a* *ø-pe* *ihe*
 1SG_{NOM} -run jungle c-to I
 “I ran to the jungle”

Object (O) = Subject of unaccusative (So)

- (8) a. *he=r-exak* *zàwàruhu* *a'e*
 1SG_{ABS} =C-see jaguar it
 “The jaguar saw me”

- b. *he=r-aku* *tata* *r-uwake i* *he*
 1SG_{ABS} =C-hot fire c-near I
 “I got warm near the fire”

When comparing the coding system of the arguments in the transitive and intransitive predicates above, we noted that there is a hybrid system of argument encoding. In short, the subject (A) of transitives align themselves with subject (Sa) of inergative verbs, triggering in the verb the first agreement paradigm (nominative system); in turn, the object (O) of transitives aligns itself with the subject (So) of unaccusative-descriptive verbs, triggering in the second verb the agreement paradigm (absolutive system). Duarte (2007:53) illustrates this system as follows:

Table 4. Split system in independent clauses

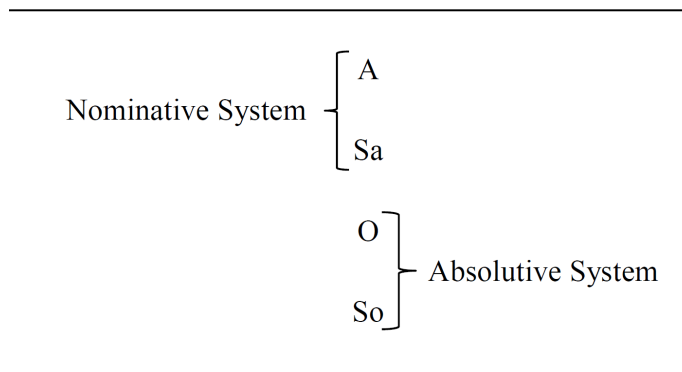

3.2. Antipassive with the morpheme {puru-}

The antipassive structure in Tenetehára, as well as in other languages identified in the previous section, although syntactically selecting two nuclear arguments, behaves, in formal terms, as intransitive sentences, since (i) the antipassivized verbs receive intransitive morphology and (ii) the abstract internal argument Case is not valued by the verb, but rather by a postposition.

Castro (2013), following the insights of Harrison (1995:93), suggests that generally, the antipassivization process in Tenetehára triggers, descriptively, the following changes:

- (9) (i) the verb receives the antipassive voice prefix {*puru*-};
 (ii) the verb receives the desiderative verb {-*wer*};
 (iii) the verb obligatorily triggers the second paradigm of agreement prefixes;
 (iv) the DP object receives the postposition *-ehe*, thus becoming a PP.

For illustrative purposes, see the following examples that illustrate the grammatical features listed above:

- (10) a. *u-pyhyk* *kwarer* *pira* *a'e*
 3_{NOM} -catch boy fish he
 “The boy caught the fish”
- b. *i-puru-pyhyk-wer* *kwarer* *pira* *r-ehe* *a'e*
 3_{ABS} -APASS-catch-WANT boy fish C-PSP he
 “The boy wants to catch the fish”

In descriptive terms, note that the example (10b) above exemplifies well the characteristics in (9), since it has the following grammatical properties:

- (11) (i) the verb *pyhyk* “catch” gets the antipassive morpheme {*puru*-};
 (ii) this verb occurs with the desiderative verb {-*wer*};
 (iii) the verb agrees with the subject *kwarer* “boy” by means of the prefix {*i*-};
 (iv) the object *pira* “fish” gets the postposition *-ehe*.

Given the above data and the data from other languages presented in the previous section, we assume, henceforth, that the sentence in (10b) actually is an antipassive construction in Tenetehára. The first evidence for this hypothesis comes from the fact that, in the active transitive constructions, the verb can agree with its subject or with its object, as shown in the examples below. It is important to note that the choice of agreement morphemes in the verb depends on the person hierarchy, and that the agreement that must appear on the verb depends on which argument is higher in this hierarchy. It is the case, therefore, that such a restriction explains why the verb receives the first person clitic to refer to the object in (12b) and the nominative verbal prefix to encode the subject in (12a). Compare to the following examples:

- (12) a. *a-exak* *kwarer* *ihe*
1SG_{NOM} -see boy I
 “I saw the boy”
- b. *he=r-exak* *kwarer* *a’e*
1SG_{ABS} =C-see boy he
 “The boy saw me”

However, another agreement pattern emerges in antipassive structures. Such a system is evident when comparing the data below with the examples above. Therefore, please note that, in (13), the verb can only agree with the subject, even if the object is higher in the person of hierarchy, as is the situation in (13b).

- (13) a. *he=ø-puru-exak-wer* *kwarer* *r-ehe* *ihe*
1SG_{ABS} =C-APASS-see-WANT boy C-PSP I
 “I want to see the boy”
- b. *i-puru-exak-wer* *kwarer* *he=r-ehe* *a’e*
3_{ABS} -APASS-see-WANT boy 1SG=C-PSP he
 “The boy wants to see me”

Note that, in the examples above, only the absolutive system’s prefixes can be activated, even if the agreement occurs with the external argument, as is the case in (13a). If such structures actually were transitive, the prefixes of the nominative system would have to occur. However, this is not the pattern that is observed, since the nominative prefixes never occur when a construction is antipassive. Thus, this restriction explains the reason for ungrammaticality of the following sentences:

- (14) a. **a-puru-exak-wer* *kwarer* *r-ehe* *ihe*
1SG_{NOM} -APASS-see-WANT boy C-PSP I
 “I want to see the boy”
- b. **u-puru-exak-wer* *kwarer* *he=r-ehe* *a’e*
3_{NOM} -APASS-see-WANT boy 1SG=C-PSP he
 “The boy wants to see me”

It is worth noting that the verbs receiving the antipassive morpheme {*puru-*} trigger the same series of agreement prefixes of unaccusative verbs, as in the examples below:

- (15) *i-àkàzým* *kwarer* *a'e*
 3_{ABS} -faint boy he
 "The boy fainted"
- (16) *i-kuhem-katu* *kwarer* *a'e*
 3abs-moan-ints boy he
 "The boy moaned a lot"
- (17) *i-àrew* *kwarer* *i-àpo-haw-ràm* *a'e*
 3_{ABS} -delay boy 3_{ABS} -do-NOML-FUT he
 "The boy delayed doing it"

The second piece of evidence that the structures with the morpheme {*puru-*} are really antipassive stems from the fact that only transitive constructions allow reflexivization by means of the morpheme {*ze-*}. Thus, the expectation is that the antipassive constructions, to be grammatically intransitive, will have to provide the same restriction on the possibility of occurrence or not of the reflexive {*ze-*}. This prediction is in fact confirmed by the judgment of the ungrammaticality of (18b).

- (18) a. *u-ze-exak* *kuzà* *a'e*
 3_{NOM} -REFL-see woman she
 "The woman saw herself"
- b'. **i-ze-puru-exak-wer* *kuzà* *a'e*
 3_{ABS} -REFL-APASS-see-WANT woman she
 "The woman wants to see herself"
- b''. **i-puru-ze-exak-wer* *kuzà* *a'e*
 3_{ABS} -APASS-REFL-see-WANT woman she
 "The woman wants to see herself"

We understand that ungrammaticality of (18b) comes from purely morphosyntactic factors, since there are apparently no semantic constraints that would prevent the derivation. The following examples confirm this assumption, since the antipassive presents another morphosyntactic strategy to cover the reflexive constructions in the language.

- c. *i-puru-exak-wer* *kuzà* *u-ze-ehe* *a'e*
 3_{ABS} -APASS-see-WANT woman CORR-REFL-PSP she
 "The woman wants to see herself"

The grammaticality of (18c) shows that it is not semantic factors that prevent sentences like (18b) to occur, but factors purely related to the syntactic structure. Therefore, our hypothesis is that this morpheme may appear only in active transitive constructions, never in intransitive and antipassive structures.

Another proof of our hypothesis comes from the fact that, since antipassivization implies reduction of valence, verbs that are originally intransitive cannot be submitted to antipassivation, as shown below:

- (19) a. *u-zahak* *kwarer* *a'e*
 3_{NOM} -bathe boy he
 “The boy bathed (took a bath)”
- b. **i-puru-zahak-wer* *kwarer* *a'e*
 3_{ABS} -APASS-bathe-WANT boy he
 “The boy wants to take a bath”

For intransitive verbs to be antipassivized they must first be submitted to a process that increases their valence. Thus, only after becoming transitive, can they be antipassivized. Note that in (20a), the verb *zahak* “swim” is transitivized by means of the causative morpheme {*mu-*}, and in (21a) it is transitivized by means of the comitative applicative morpheme {*eru-*}.

- (20) a. *u-mu-zahak* *kuzà* *kwarer* *a'e*
 3_{NOM} -CAUS-bathe woman boy she
 “The woman caused the boy to take a bath”
- b. *i-puru-mu-zahak-wer* *kuzà* *kwarer* *r-ehe* *a'e*
 3_{ABS} -APASS-CAUS-bathe-WANT woman boy C-PSP she
 “The woman wants to give a bath to the boy”
- (21) a. *w-eru-zahak* *kuzà* *kwarer* *a'e*
 3_{NOM} -APPL-bathe woman boy she
 “The woman took a bath with the boy”
- b. *i-puru-eru-zahak-wer* *kuzà* *kwarer* *r-ehe* *a'e*
 3_{ABS} -APASS-APPL-bathe-WANT woman boy C-PSP she
 “The woman wants to take a bath with the boy”

It is interesting still to note that intransitive structures as in (19a) can be subjected to desiderative constructions as the examples below demonstrate. The result, however, will not be an antipassive configuration, since (i) the antipassive morpheme {*puru-*} and (ii) the postposition *-ehe* do not appear.

(22) *i-zahak-wer* *kwarer* *a'e* (compare with 19b)
 3_{ABS} -bathe-WANT boy he
 “The boy wants to take a bath”

(23) *i-ker-wer* *kwarer* *a'e* *kury*
 3_{ABS} -sleep-WANT boy he now
 “The boy wants to sleep now”

Other evidence in favor of the construction with the morpheme {*puru-*} really being an antipassive in Tenetehára has to do with the fact that, in antipassivization, the internal argument does not have Case valued by the verb, but by the postposition *-ehe*, according to the data shown in (24b) below. If the postposition does not appear, the sentence becomes ungrammatical as (24c).

(24) a. *u-pyhyk* *kwarer* *pira* *a'e*
 3_{NOM} -catch boy fish he
 “The boy caught the fish”

b. *i-puru-pyhyk-wer* *kwarer* *pira* *r-ehe* *a'e*
 3_{ABS} -APASS-catch-WANT boy fish C-PSP he
 “The boy wants to catch the fish”

c. **i-puru-pyhyk-wer* *kwarer* *pira* *a'e*
 3_{ABS} -APASS-catch-WANT boy fish he
 “The boy wants to catch the fish”

Finally, aspectual relations such as telicity are also involved in switching between transitive and antipassive. According to Spreng (2001), the events in antipassive constructions can have an imperfective reading. Interestingly, note that the imperfective reading is also obtained in the antipassive constructions in Tenetehára, as in (25b), since the desiderative {-*wer*} must always be present in such structures.

(25) a. *u-mimoz* *kuzà* *zytyk* *a'e*
 3_{NOM} -cook woman potato she
 “The woman cooked the potato”

b. *i-puru-mimoz-wer* *kuzà* *zytyk* *r-ehe* *a'e*
 3_{ABS} -APASS-cook-WANT woman potato C-PSP she
 “The woman wanted to cook the potato”

Moreover, transitive constructions, according to example (25a), have the property [+telic], since they possess an action or an activity that ends with a

clear realization (cf. Nolasko 2009). More precisely, the construction in (25a) involves an accomplishment which is characterized by being, at one time, durative and telic. Thus it requires more than one atom of time to take place. In short, the active construction aims at an end to be reached. However, in example (25b), the event “want to cook” does not necessarily imply that the event ever happened. Nevertheless, it has the property [-telic] when compared to the transitive construction in (25a).

4. Theoretical proposal

We showed in the previous section that constructions with the {*puru-*} morpheme in Tenetehára have exactly the same characteristics as antipassive constructions in the languages analyzed in section 1. Moreover, by constituting a subtype of intransitive structure, the purpose of this section is to present a theoretical proposal in order to capture the mechanism that allows the valuation of ϕ -features of the VP’s antipassive head and of the Case features of its subject. To develop the theoretical analysis, we will assume here what is the basic part of the Wurmbrand’s (2011, 2012, 2013) proposal, whereby the ν P has a system of valuation of features that can be inserted as follows: valued (F: val) or not valued (F: $__$). When one of these features is introduced but not valued, the valuation is determined contextually, thus allowing different kinds of structures. Furthermore, this approach provides a unified system for the various types of constructions. This valuing system is defined in (26) and is implemented in an illustrative form in (27).

Reverse agreement

- (26) A feature F: $__$ in α is valued by the feature F: *val* in β , if and only if
- (i) β asymmetrically c-commands α ;
 - (ii) there is no γ , γ different from β , with an interpretable and valued features such that γ commands α and is c-commanded by β .

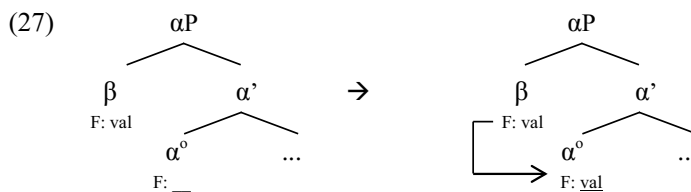

4.1. Valuation of features- ϕ and Case features in intransitive and transitive structures

Before looking at the antipassive structures in Tenetehára, we first present the derivations of transitive and intransitive predications. The features involved in this analysis are summarized in (28). Let us assume that the TP's heads values the nominative Case of the external argument DP in transitive constructions, while the ν P's transitive head values the accusative Case features of the internal argument. The projection of intransitive and antipassive ν P, in turn, has a head that, because it does not contain a Case feature, is unable to value a DP that eventually c-commands. This is the reason why the TP's head will be the one responsible for valuing the Case features of the arguments of intransitive predications (both in unergative constructions and in unaccusative-descriptive structures).

Head's features of TP and ν P in Tenetehára	
(28) T ^o :	[C: NOM]
ν^o_{Tran} :	[C: ACC] [ϕ : ____]
ν^o_{Intr} :	[C: without Case] [ϕ : val / ____]
ν^o_{Apass} :	[C: without Case] [ϕ : val]

For this reason, from now on we will assume that the agreement prefixes in this language are not necessarily associated with the valuation of Case, but with the valuation relations of ϕ -features. We propose that this valuation can be performed in two ways, namely: (i) by movement of the inner argument to the heads of ν P or (ii) by means of agreement between the heads of ν P and the inner argument. For the first situation, the internal argument pronoun moves to the ν P head, cliticizing to the verb. The spell-out of this derivation will, therefore, because the personal pronoun clitics to move next to the head of ν^o , as can be seen below:

(29) *he=ø-katu-ahy*
1SG_{ABS} =c-be.good-INTS
 "I'm very well"

(30) *he=r-exak* *kwarer*
1SG_{ABS} =c-see boy
 "The boy saw me"

For the second situation, there is an agreement relationship between the ν P head and the nominal element (DP) that immediately c-commands it. Our

hypothesis is that the rules in (31) and (32) determine the agreement paradigm in Tenetehára.

- (31) The verb triggers the first agreement paradigm (nominative system), if
 - (i) the features φ : DP *val* that c-commands v^o values the features φ : __ of v^o ;
 - (ii) the DP bearing the features φ : *val* is the result of external *merge*.
- (32) The verb drives the second agreement paradigm (absolutive system), if
 - (i) the features φ : DP *val* that c-commands v^o values the features φ : __ of v^o ;
 - (ii) the DP bearing the features φ : *val* is the result of internal *merge* (movement).

In order to illustrate the relevant derivations for our discussion, see the transitive clause below, in which the verb triggers the first agreement paradigm. Note that the verb triggers these prefixes because there is an agreement relationship, in terms of the φ -features, between the head v^o and the external argument DP, which enters the derivation through external *merge*. Furthermore, the abstract Case of this external argument DP is valued by the TP’s head, which carries the feature C: NOM.

- (33) a. *w-exak* *awa* *kwarer*
 3_{NOM}-see man boy
 “The man saw the boy”

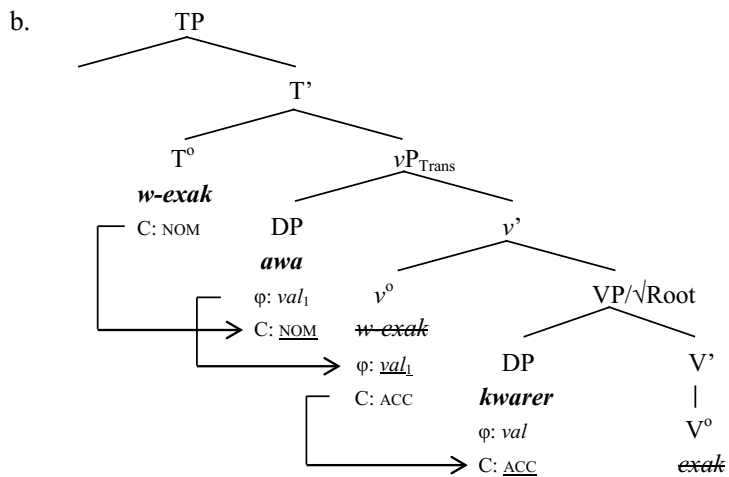

Note that the external argument DP and the internal argument DP have their Case features valued, respectively, by T⁰ and v^o. In addition, the φ -features of v^o is valued by the external argument DP, which triggers in the verb the first agreement paradigm. While the first paradigm is the result of an agreement relationship between the external argument DP and the vP’s head, we propose

that the second paradigm is actually the result of the movement of the internal argument, when it is realized by the pronominal clitics, to the head of *vP*. For this reason, the spell-out of this derivation is a transitive verb with its object pronoun cliticized. Note that, after the object movement, the ϕ -feature of *vP*'s head is valued, whereas the Case features of the object is deleted.

- (34) a. *he=r-exak* *awa*
 1SG_{ABS} =C-see man
 "The man saw me"

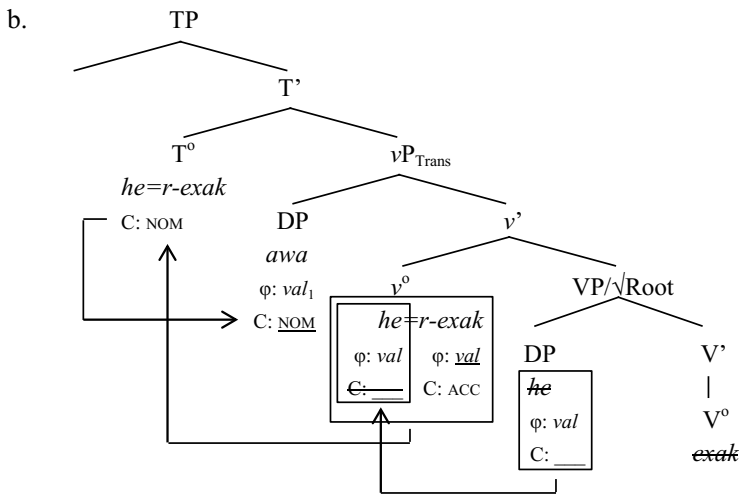

Observe that the above analysis conforms to the hypothesis that Case and agreement are dissociated. In the intransitive constructions, for example, there is only one source of Case valuation, namely: the TP's head, which values the nominative Case, although we see that there are two patterns of agreement, which are determined by the semantic nature of the verb. The unergative verbs trigger the prefixes of the first paradigm, according to the formulation in (31), and unaccusative-descriptive verbs may either trigger the movement of the pronominal argument to *v*⁰ or trigger absolutive prefixes of the second paradigm in the verb, as proposed by the correlation (32).

In an approach that adopts the proposed two-way relationship between Case and agreement, considering that the first paradigm is the result of the valuation of the nominative Case by means of the head *T*⁰, we are led to stipulate that the head *v*⁰, which values the accusative Case in transitive sentences, is what is responsible for triggering the second agreement paradigm.

However, we assume, henceforth, that unaccusative-descriptive verbs, although they may trigger the prefixes of the second paradigm, when the subject is third person, do not project a *vP* able to valuing the accusative Case. For

this reason, we adopt the hypothesis that the occurrence of the nominative prefixes is only the grammatical reflex of the agreement operation, in terms of φ -features, which is between the νP 's head and the external argument DP. In turn, the occurrence of the absolutive prefixes of the second paradigm can be interpreted only as the spell-out of the agreement in terms of φ -feature, between the νP 's head and the internal argument DP, when this undergoes movement to a position joined to the verb that c-commands it. Note: the core of this proposal is that agreement is not necessarily associated with the valuation of abstract Case. For this, compare the examples below:

(35) *u-zàn* *kwarer*
 3_{NOM} -run boy
 "The boy ran"

(36) *i-kàg* *kwarer*
 3_{ABS} -be.strong boy
 "The boy is strong"

In order to capture the lack of association between agreement and Case, we propose that the intransitive sentences above have, in the end, the same syntactic derivations. Following this line of reasoning, we propose that, in the sentence below, the nominative prefix {*u-*}, belonging to the paradigm of the first agreement series, appears in the verb as the result of the valuation of the feature φ : of ν^0 by the feature φ : *val* of the DP which occupies the external argument position, which is the result of external *merge*, according to the formulation proposed in (31). The head T^0 , in turn, values the nominative Case of the subject.

(37) a. *u-zegar* *kwarer*
 3_{NOM} -sing boy
 "The boy sang"

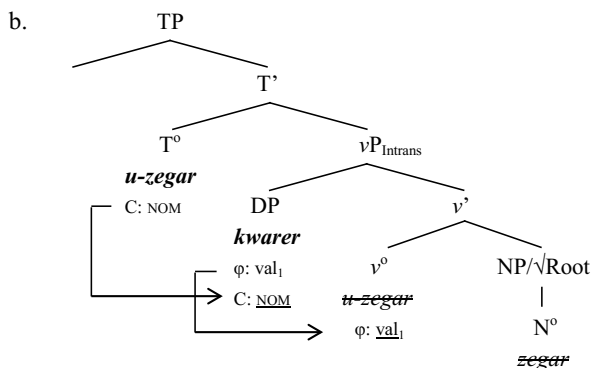

Unlike unergative verbs that trigger the first agreement paradigm, as in (37), we propose that unaccusative verbs, as shown in the example below, trigger the second agreement prefix paradigm. In the example below, the prefix {i-} occurs, and the occurrence can be interpreted as the result of the valuation of the feature φ : ___ of v^0 by the feature φ : val_1 of the DP *kuzà* “woman”, which is generated in Spec-AP. Therefore, this correlation should be interpreted as being the result of the internal *merge* (movement) of this DP in Spec- vP . At an earlier stage of the syntactic derivation, this DP receives nominative Case when the head T^0 is joined to $vP_{intrans}$. The complete derivation of the sentence (38a) is shown below:

- (38) a. *i-puràg* *kuzà*
 3_{ABS}-be.beautiful woman
 “The woman is beautiful”

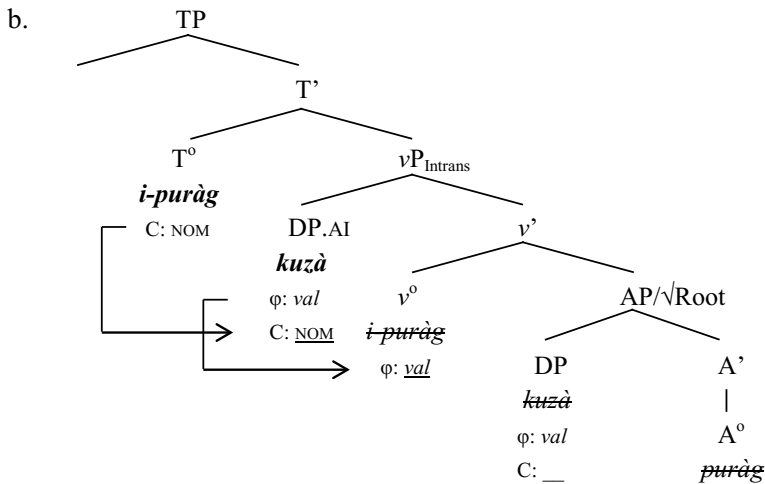

Additional evidence in favor of saying the subjects of unaccusative-descriptive verbs are actually generated in the internal argument position and moved to Spec- vP arises from the fact that they can be incorporated into the verb, as we can see in the following example:

- (39) a. *he=∅-kuhem-katu* *pyhaw*
 1SG_{ABS}=C-moan-INTS at.night
 “I moaned at night”

In relation to the subject of unergative verbs, our proposal is that these are generated directly in the external argument position of vP , position from which the v^0 agreement features are valued. For this reason, they are unable to cliticize to the unergative verb, as shown in the following example:

- (39) b. *a-zàn* *ihe*
 1SG_{NOM}-run I
 “I ran”

4.2. Valuation of ϕ -features and Case features in antipassives

In this subsection, the goal is to propose a derivation for the antipassive constructions in Tenetehára. Within the relational grammar model and typology, for example, antipassive structure is seen as a derived construction in which the object is somehow “demoted” (cf. Baker 1988; Cooreman 1994; Dixon 1979, 1994; England 1988; Palmer 1994; among others). However, such an analysis is difficult to accommodate in a generative syntactic analysis, since “demoting” would involve a transformational movement downward. In view of Chomsky (1995), each *merge* operation should extend the derivation, thereby preventing downward movement. More recently, according to the *No-Tampering Condition*, as proposed by Chomsky (2005), the movement leaves unchanged the objects to which it applies, forming an extended object. Moreover, it is still difficult to locate the place where the object of the antipassive comes down, since the demoted object is typically an internal argument with the thematic roles of theme and affected. Therefore it is not possible to have a c-commanded position for the object to which it moves, for the demotion operation to be applied. For this reason, we will adopt an approach contrary to the demotion of object. More precisely, we assume that all the characteristics of antipassives in Tenetehára can be explained by the analysis proposed in the previous subsection. Generally speaking, instead of “demotion”, the antipassive structure corresponds, in fact, to a syntactic configuration in which the object does not undergo a syntactic derivation that usually occurs in transitive constructions. In this line of reasoning, our proposal is that the antipassive head *vP* has no features Case to value, i.e., it is defective in this regard. Therefore, this head is unable to value the abstract Case of the internal argument. For this reason, the internal argument cannot have its Case features valued by *vP*’s head. Then a way to save the structure is to make the object receive the oblique Case of the postposition *-ehe*, such as we show in the following:

- (40) a. *i-puru-mimoz-wer* *t-àmuz* *ma’ero’okwer* *r-ehe*
 3_{ABS} -APASS-COOK-WANT 3-grandfather meat C-PSP
 “The grandfather wants to cook the meat”

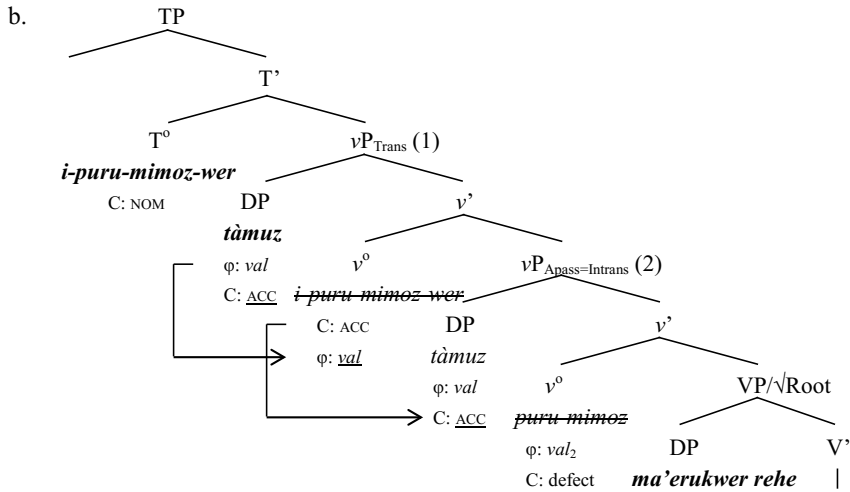

Note that we are assuming, at this point in the analysis, that the desiderative {-wer} is the instantiation of a restructuring verb, whose semantics is that of volition and of desire. Thus, this suffix realizes morphologically the vP's head, which contains the following features: (i) the accusative Case features (= C: ACC), which values the Case of the external argument of the embedded structure, and (ii) the φ-feature: $__$ to be valued by a DP that c-commands the head v⁰. It is, therefore, the v⁰ head, morphologically realized by the morpheme {-wer}, which values the Case of the DP external argument of the embedded predication, which moves from the position Spec-vP_{Intrans} to position Spec-vP_{Trans} of the main predication. In this position, the external argument values the feature φ: $__$ of v⁰_{Trans}.

Since the agreement, in terms of φ-feature, is established between the v⁰_{Trans} head and a DP introduced through an internal *merge* (movement), the verb may only appear with the absolutive prefixes listed under the second paradigm of agreement, as was proposed in (32).

5. Final Remarks

In this article, we wanted to describe and examine the antipassive constructions in the Tenetehára language (Tupi-Guarani). We showed that the transitive verbs, on receiving the morpheme {puru-}, begin to present, interlinguistically, properties typical of antipassive constructions. We demonstrated that these antipassive constructions, although syntactically selecting two nuclear arguments, behave, in formal terms, as intransitive clauses, since, in general, they receive intransitive morphologies and the abstract Case of the internal argument is not valued by the verb, but by the postposition *-ehe*.

In a strictly syntactic minimalist approach, we proposed the way the antipassive constructions are derived in Tenetehára. For this, we argue that the

main difference between an antipassive clause and a transitive clause is that although the antipassive ν P selects an external argument, its head is not able to value the abstract Case of the internal argument. For this reason, the object is then dependent on the postposition *-ehe* for the oblique Case. Furthermore, unlike what happens in the derivation of transitive constructions, the antipassive ν P's ϕ -feature is already valued, which does not allow the agreement, in terms of ϕ -features, with its external argument. The result is that this external argument moves to the ν P Spec position highest in the tree structure, whose head is instantiated by the desiderative verb $\{-wer\}$, with which it establishes an agreement relationship in terms of ϕ -feature. While the agreement of the ν P's transitive head with its external argument (external *merge*) triggers in the verb the first agreement paradigm (nominative system), the agreement of the ν P head, the head of which is occupied by the morpheme $\{-wer\}$, with its external argument (internal *merge*) triggers the second agreement paradigm (absolutive system).

References

- Aldridge, E. 2012. Antipassive and ergativity in Tagalog. *Lingua*: 122(3):192-203.
- Baker, M. C. 1988. *Incorporation: a theory of grammatical function changing*. Chicago: University of Chicago Press.
- Bittner, M. 1987. On the semantics of the Greenlandic antipassive and related constructions. *International Journal of American Linguistics* 53:194-231.
- Blight, R. C. 2004. *Head Movement, Passive and Antipassive in English*. Ph.D. dissertation, UT, Austin, TX.
- Camargos, Q. F. 2010. *Para onde foram os adjetivos em Tenetehára?* Monograph, UFMG, Belo Horizonte, MG.
- Camargos, Q. F. 2015. Exploring agreement displacement from the IA to the EA in the Tenetehára language (Tupí-Guaraní). In Handout of the Talk, July 1, 2015, *GTTG da Anpoll*. Universidade Federal de Minas Gerais, Belo Horizonte.
- Castro, R. C. 2013. O epifenômeno da alternância de valência na língua Tenetehára (Tupí-Guaraní). *Revista da Anpoll* 34:347-391.
- Chomsky, N. 1995. *The Minimalist Program*. Cambridge: The MIT Press.
- Chomsky, N. 2005. Three factors in language design. *Linguistic Inquiry* 36:1-22
- Cooreman, A. 1994. A functional typology of antipassive. In *Voice: form and function*, ed. B. Fox, P. Hopper, 49-86. Amsterdam: John Benjamins Publishing.
- Dixon, R. M. W. 1979. Ergativity. *Language* 55:59-138.
- Dixon, R. M. W. 1994. *Ergativity*. Cambridge: Cambridge University Press.
- Duarte, F. B. 2005a. Propriedades denotacionais dos prefixos $\{i-\}$ e $\{h-\}$ em Tenetehára. *Revista Estudos Linguísticos* 34:1194-1199.

- Duarte, F. B. 2005b. Codificação de argumentos e ergatividade (cindida) em Tenetehára. *Revista LIAMES* 5:111-142.
- Duarte, F. B. 2007. *Estudos de morfossintaxe Tenetehára*. Belo Horizonte: FALE-UFMG Press.
- Duarte, F. B. 2012. Tenetehára: a predicate fronting Language. *The Canadian Journal of Linguistics* 57(3):359-386.
- England, N. C. 1988. Mam Voice. In *Passive and Voice*, ed. M. Shibatani, 525-545. Amsterdam: John Benjamins Publishing.
- Givón, T. 1993. *English Grammar: a functional-typological introduction*. Amsterdam: John Benjamins Publishing.
- Harrison, C. 1995. The interplay of causative and desiderative in Guajajara. *Revista dos Cursos de Pós-Graduação em Letras* 4:83-114.
- Nolasco, R. 2009. *What Philippine ergativity really means*. Baguio: University of the Philippines.
- Palmer, F. R. 1994. *Grammatical Roles and Relations*. Cambridge: Cambridge University Press.
- Polinsky, M. 2005. Antipassive constructions. In *The World Atlas of Language Structures*, ed. M. Haspelmath, M. S. Dryer, D. Gil, B. Comrie. Oxford: Oxford University Press.
- Rodrigues, A. D. 1985. Relações internas na família lingüística Tupí-Guaraní. *Revista de Antropologia* 27/28:33-53.
- Rodrigues, A. D. 1990. You and I=neither you nor I: the personal system of Tupinambá. In *Amazonian linguistics: Studies in lowland South American languages*, ed. D. L. Payne, 393-405. Austin: University of Texas Press.
- Silverstein, M. 1976. Hierarchy of features and ergativity. In *Grammatical categories in Australian languages*, ed. R. M. W. Dixon, 112-171. New Jersey: Humanities Press.
- Spreng, B. 2001. Little *v* in inuktitut: antipassive revisited. *Linguistica atlântica* 23:155-190.
- Wurmbrand, S. 2011. *On Agree and Merge*. Storrs: University of Connecticut.
- Wurmbrand, S. 2012. Parasitic participles: evidence for the theory of verb clusters. *Taal en Tongval*, 64:129-156.
- Wurmbrand, S., 2013. The features of voice. In: Handout of the Talk, October 26, 2013, *Little v Workshop*. Leiden University, Holland.

Recebido em 5 de maio de 2016

Aceito em 3 de junho de 2016